





APPROVAL	 Certification Link	 Certification Link
Electrical		
Standard	UL	IEC
Rated voltage	150V	320V
Rated current	12A	20A
Withstanding voltage	2500V/1Min	
Mechanical		
Ambient temperature	-40°C~+105°C	
Dimensions		
Pitch	5.08mm(.200")	
Poles	2P-24P	
Material		
Housing	PA66,UL94V-0	
Pin header	Copper, Tin plated	



HOW TO ORDER :

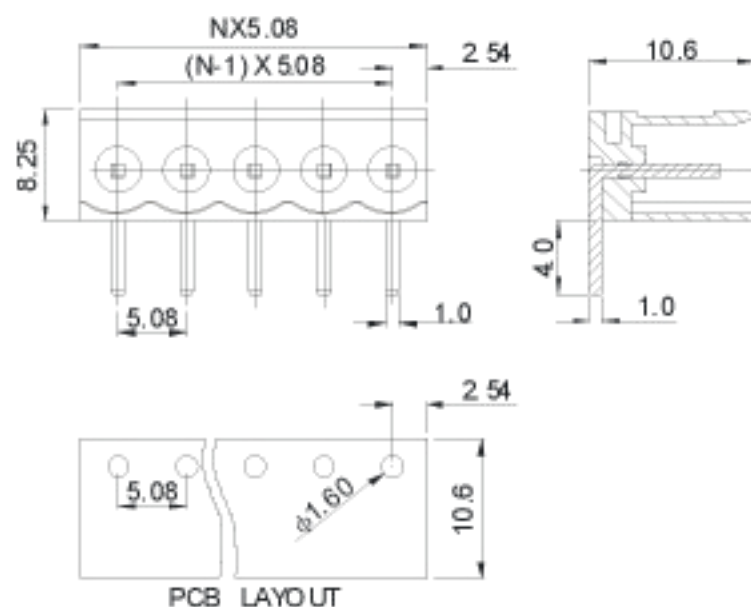
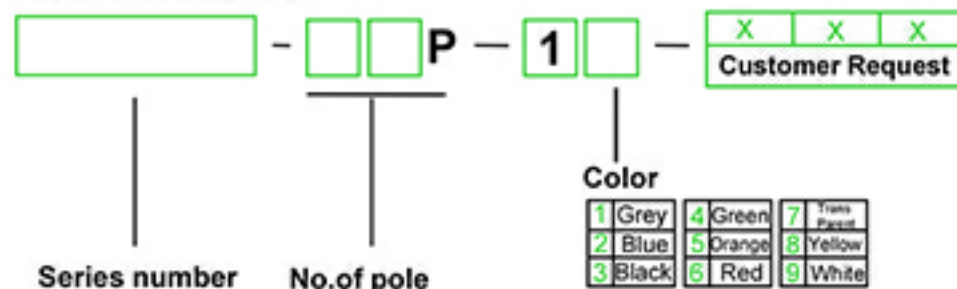
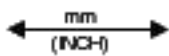

	 China · Kang Wei electronics co., LTD
	NAME HT508R-5.08